

**NEXOPART**

simplicity for your lab



# Precision down to the smallest detail

As you well know, every detail counts. Thanks to our "simplicity for your lab" approach, with NEXOPART you will experience a seamless workflow that allows you to concentrate on what matters most – maximum precision in the analysis of particles. Say goodbye to complex procedures and hello to powerful tools that will simplify your daily lab routine!

Our modern and robust measuring instruments ensure that not a single particle is left undetected. Even if your work involves microscopic particles, our solutions deliver highly accurate and reliable analyses.

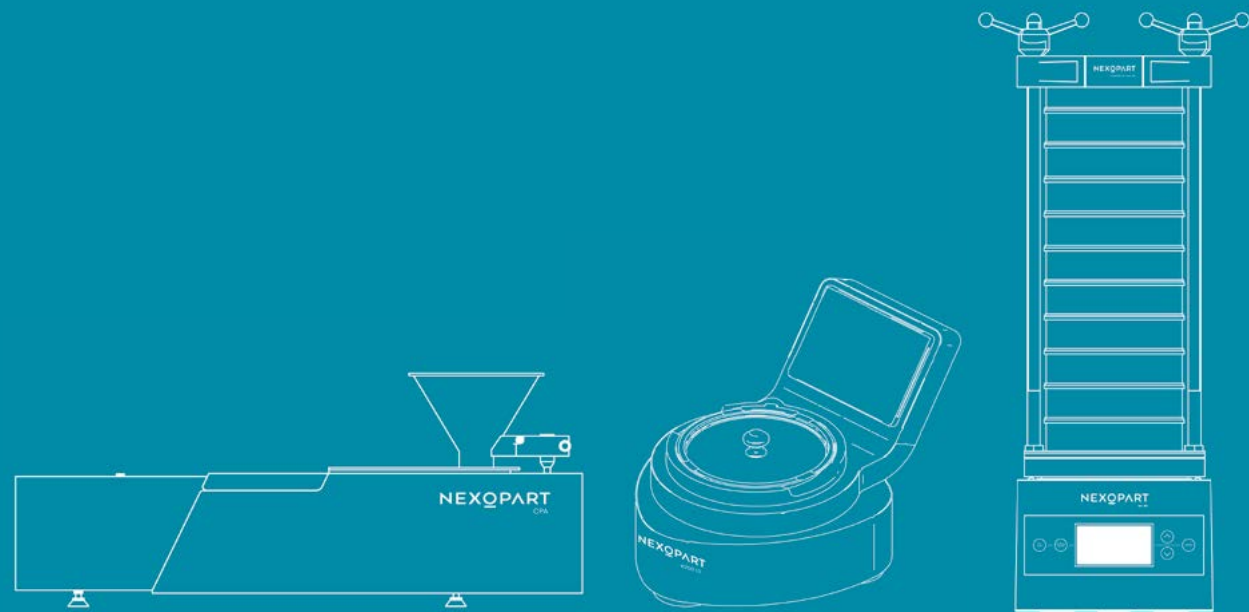

We are aware of our customers' specific requirements and can therefore offer you everything from our comprehensive product portfolio that you need for standard-compliant sieve analyses. From test sieves, test sieve machines, particle measurement equipment for dynamic image analysis to analysis software, we supply everything you need from a single source.

## For all those who value precision

# Your reliable companion in the laboratory

We cover a wide range of your applications, including sand, soil, construction materials, food products, active pharmaceutical ingredients, recycling materials, chemical production, plastics, color pigments, toners, specialty coatings and much more.



Medicine and pharmaceuticals



Construction materials and asphalt



Chemicals



Fertilizers



Refractories



Animal feed



Research and education



Granulates and pellets



Paint powders and pigments



Food, sugar and salt



Sand, crushed stones and gravel



Grinding and blasting abrasive

## at all levels.

# The next era in particle analysis

NEXOPART was established as a joint venture in 2023. The 'Particle Analysis' division of Haver & Boecker oHG and the Air Jet Sieving division of Hosokawa Alpine AG have merged into one company - a new brand.

NEXOPART represents the next era in particle analysis - a young, dynamic and innovative company coupled with the experience, expertise and stability of the two parent companies.

With decades of international experience and the know-how of our employees, we combine tradition with innovation. Our customers motivate us to constantly improve our products and manufacturing processes. This enables us to meet the needs of our customers quickly, flexibly and always at a very high standard.

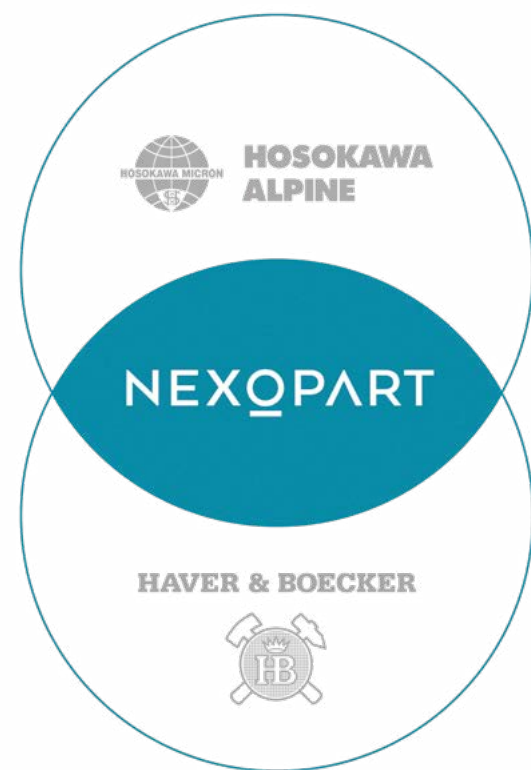

A Haver & Boecker and Hosokawa Alpine Company

For more information about NEXOPART, visit:

[www.nexopart.com](http://www.nexopart.com)



# Your strong partner with certified assurance

Be inspired by our NEXOPART products. We use only high quality materials for our products to ensure that they comply with European directives. Our test sieves and test sieve machines are manufactured in Germany. We are thus able to ensure sustainability, due to short transport routes and largely secured supply chains. For you the customer, this means excellent product availability, short delivery times and fast service directly on site.

- 24-month warranty
- Produced in Germany
- Products comply with European directives
- Simple and quick commissioning
- Tested and calibrated products
- Original and genuine
- Quality and service
- Worldwide distribution network
- 24 hours a day, 7 days a week





# Sieve analysis. Simplicity meets precision

Sieve analysis is a reliable and proven method. NEXOPART offers suitable test sieves designed to meet all of your sieving requirements. No matter if you need test sieves with woven wire cloth manufactured in accordance with ISO 3310-1, robust square perforated plates produced in accordance with ISO 3310-2 for sieving of road construction stone, concrete aggregates, gravel, sand, crushed stone, or slotted perforated plates for testing grain made in accordance with ISO 5223.

Our classic woven wire cloth sieve sections cover the entire standardized range of mesh sizes from 0.02 mm to 125 mm. On request, we offer test sieves with electroformed sheets for precision testing in the micrometer range. The electroformed nickel sheets have round or square apertures with holes ranging in size from 10 µm to 100 µm, standardized to 500 µm. Our test sieves are easy to use and provide you with exact results.

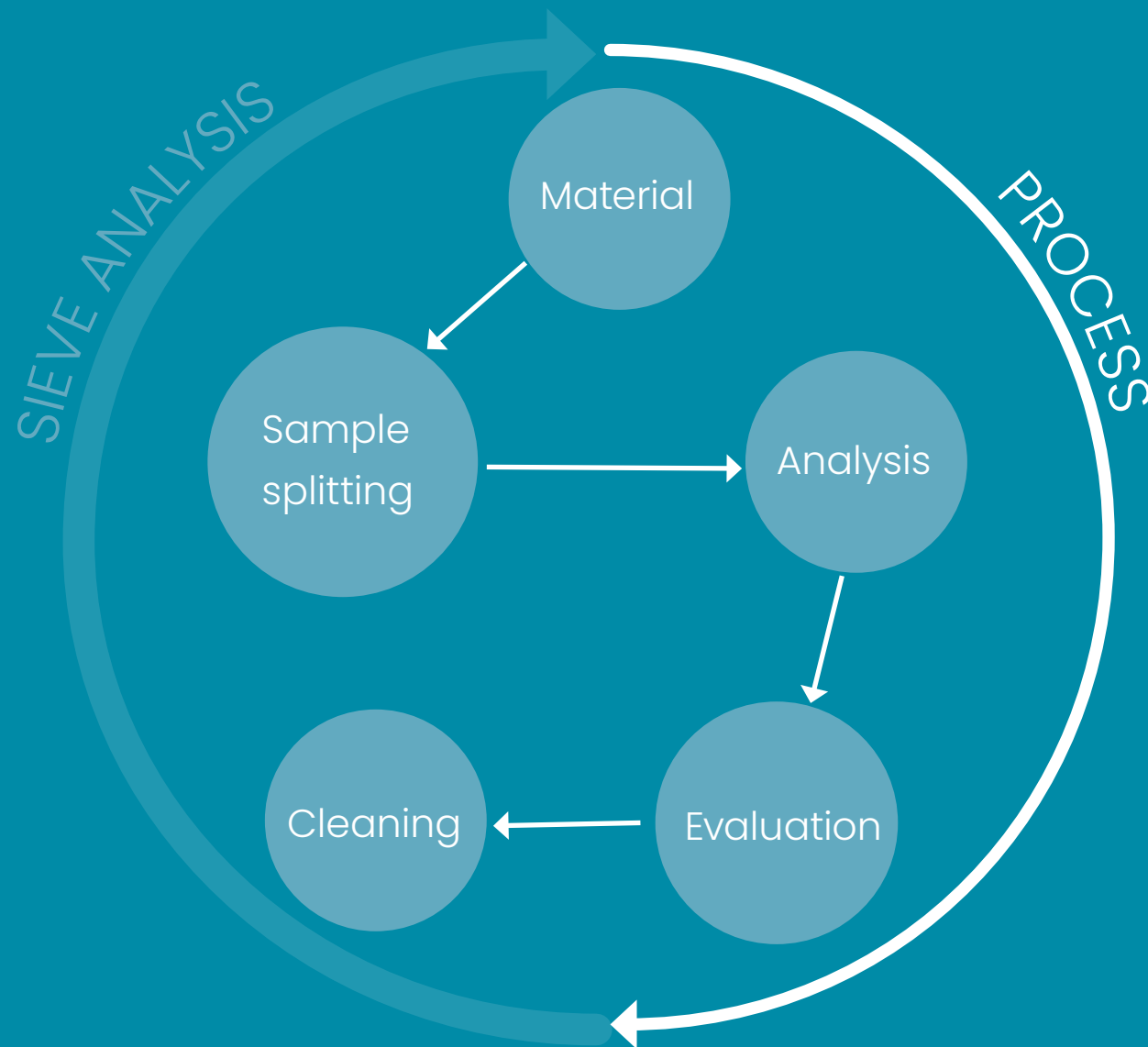

## Simple sample splitting for flawless results

Representative samples of the material must be taken in preparation for the sieve analysis. There are several sampling methods that are used for this purpose. One successful method is dividing the specimen using a **sample divider**. This process involves dividing the original quantity into two shells by means of closely spaced outlets called riffles. One half of this is removed and the other half is divided further using the same procedure until the desired sample size is reached.

In some instances, high-precision sample splitting is required. We offer you the NEXOPART **rotary sample splitter** for this purpose. It combines three splitting processes in one device: The sample is fed to a dividing cone that emulates the process of quartering and coning. The sample material on its surface is accelerated outwards by rotation and is divided through guide channels into up to 30 individual samples (depending on the model used). This way, even sluggish flowing materials such as cement and limestone can be divided with exceptionally high accuracy.



NEXOPART RPT rotary sample splitter  
1:8 - 1:10 - 1:30



NEXOPART RT 6.3 - 12.5 sample divider

NEXOPART RT 25 - 37.5 - 50 - 75 sample divider

# Test sieves. The ultimate measuring instruments

NEXOPART test sieves for particle size analysis are designed to meet the requirements for measuring instruments for sieving in accordance with ISO / IEC Guide 99:2007. Our sieves are not only highly accurate, but also extremely durable. We make sure that all of our test sieves are manufactured in accordance with current standards to guarantee you exceptionally high precision and stability.

Our test sieves are manufactured from high-quality frame materials and feature an extremely rugged sieve design developed by our team. Our meticulous workmanship ensures a long service life and proper functionality of our sieves. They are designed for all testing conditions and deliver reliable results. We are aware of the importance of simplifying your work and our sieves are tailored exactly to meet these requirements.



# Suitable and standard-compliant for every sieving task

In addition to our standard test sieves, our range of NEXOPART sieves also includes stainless steel grain and tobacco test sieves as well as square wooden frame sieves. The particularly smooth surface of our frames prevents cross contamination and the sieve wire cloth retains its tension exceedingly well even after intensive use. Manual sieving, conventional sieving, wet or dry sieving: **Analyze bulk materials from 10 µm to 125 mm with NEXOPART.**

## Wire cloth

- ISO 3310-1, ASTM E11, TYLER Screen Scale
- Nominal sizes from 20 µm to 125 mm
- Diameters from 50 mm to 450 mm

## Perforated plate with round holes

- ISO 3310-2
- Hole sizes from 1 mm to 125 mm
- Diameters from 200 mm to 450 mm

## Perforated plate with square holes

- ISO 3310-2
- Hole sizes from 4 mm to 125 mm
- Diameters from 200 mm to 450 mm

## Electroformed sheet

- ISO 3310-3, ASTM E161
- Nominal sizes from 10 µm to 500 µm
- Diameters from 76,2 mm to 200 mm





# Perfect precision in all sizes



# And all variations

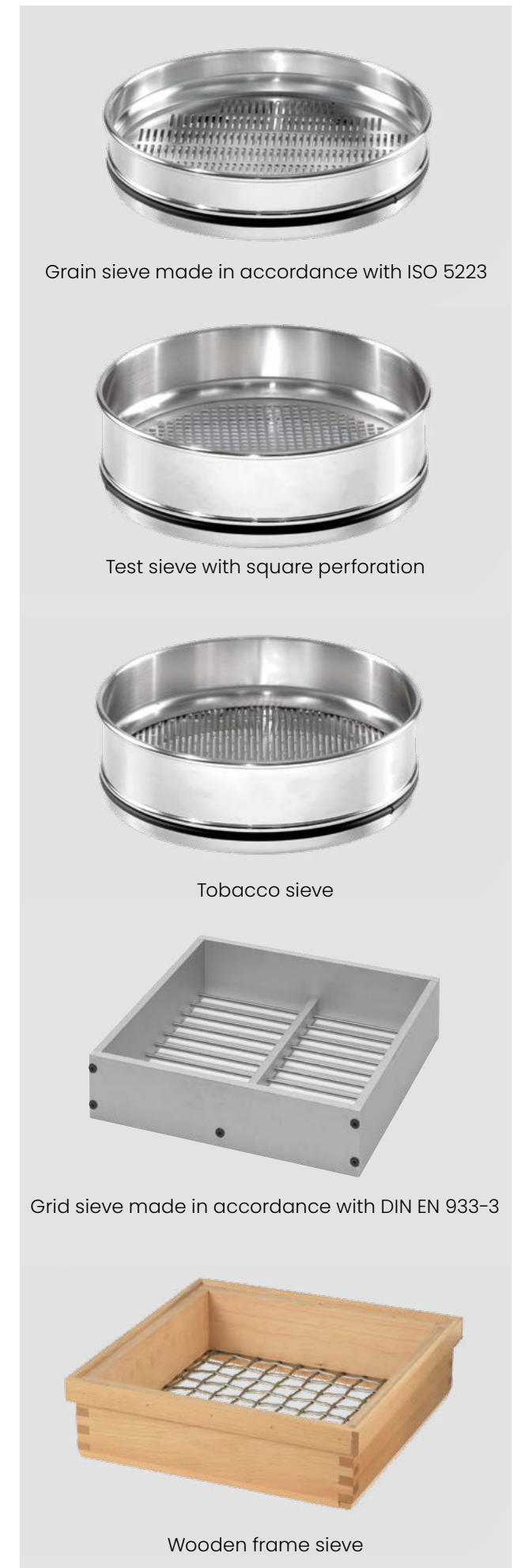

International Test Sieve Comparison Table 2025 Sieve bottom for test sieves nominal sizes of openings											
125-1 mm Table 1											
1	2	3	4	5	6	7	8	9	10	11	12
ISO 3310 Table 1, Millimetre sizes			DEU	DEU	DEU	USA		USA	USA	USA	TYLER*
Principal sizes R 20/3 R 20 R 40/3 Nominal aperture sizes acc. to ISO 565			DIN	DIN	DIN	Standard	U.S. alternative	Supplementary sizes	Standard	Standard	TYLER Screen Scale #
w	w	w	w	w	w	w	No.	w	w	w	Mesh
125	125	125	125	125	125	125	5 in.		125	125	
	112		112	112	112			112	106	106	
	100	106	106	106	106	106	4.24 in.		100	100	
90	90	90	90	90	90	90	3.1/2 in.		90	90	
	80		80	80	80			80	75	75	
	71	75	75	75	75	75	3 in.		71	71	
63	63	63	63	63	63	63	2.1/2 in.		63	63	
	56		56	56	56			56	53	53	
	50	53	53	53	53	53	2.12 in.		50	50	
45	45	45	45	45	45	45	1.3/4 in.		45	45	
	40		40	40	40			40	37.5	37.5	
	35.5	37.5	37.5	37.5	37.5	37.5	1.1/2 in.		35.5	35.5	
31.5	31.5	31.5	31.5	31.5	31.5	31.5	1.1/4 in.		31.5	31.5	
	28		28	28	28			28	26.5	26.5	1.05 in.
	25	26.5	26.5	26.5	26.5	26.5	1.06 in.		25.0	25.0	
22.4	22.4	22.4	22.4	22.4	22.4	22.4	7/8 in.		22.4	22.4	.883 in.
	20		20	20	20			20	19.0	19.0	.742 in.
	18	19	19	19	19	19.0	3/4 in.		18	18	
16	16	16	16	16	16	16.0	5/8 in.		16.0	16.0	.624 in.
	14		14	14	14			14	13.2	13.2	.525 in.
	12.5	13.2	13.2	13.2	13.2	13.2	0.530 in.		12.5	12.5	
11.2	11.2	11.2	11.2	11.2	11.2	11.2	1/2 in.		11.2	11.2	.441 in.
	10		10	10	10			10	9.5	9.5	.371 in.
	9	9.5	9.5	9.5	9.5	9.5	3/8 in.		9	9	
8	8	8	8	8	8	8.0	5/16 in.		8.0	8.0	2.1/2
	7.1		7.1	7.1	7.1			7.1	6.7	6.7	3
	6.3	6.7	6.7	6.7	6.7	6.7	0.265 in.		6.3	6.3	
5.6	5.6	5.6	5.6	5.6	5.6	5.6	1/4 in.		5.6	5.6	3.1/2
	5		5	5	5			5	4.75	4.75	4
	4.5	4.75	4.75	4.75	4.75	4.75	4		4.5	4.5	
4	4	4	4	4	4	4.00	5		4.00	4.00	5
	3.55		3.55	3.55	3.55			3.55	3.35	3.35	6
	3.15	3.35	3.35	3.35	3.35			3.15	3.15	3.15	
2.8	2.8	2.8	2.8	2.8	2.8	2.80	7		2.80	2.80	7
	2.5		2.5	2.5	2.5			2.5	2.36	2.36	8
	2.24	2.36	2.36	2.36	2.36	2.36	8		2.24	2.24	
2	2	2	2	2	2	2.00	10		2.00	2.00	9
	1.8		1.8	1.8	1.8			1.8	1.7	1.7	10
	1.6	1.7	1.7	1.7	1.7	1.70	12		1.6	1.6	
1.4	1.4	1.4	1.4	1.4	1.4	1.40	14		1.40	1.40	12
	1.25		1.25	1.25	1.25			1.25	1.18	1.18	14
	1.12	1.18	1.18	1.18	1.18	1.18	16		1.12	1.12	
1	1	1	1	1	1	1.00	18		1.00	1.00	16

International Test Sieve Comparison Table 2025 Sieve bottom for test sieves nominal sizes of openings											
900-5 µm Table 2											
1	2	3	4	5	6	7	8	9	10	11	
ISO 3310 Table 2, Micrometre sizes			DEU	DEU		USA	USA		USA	TYLER*	
Principal sizes R 20/3 R 20 R 40/3 Nominal aperture sizes acc. to ISO 565			DIN	DIN		Standard	U.S. alternative	Supplementary sizes	Standard	TYLER Screen Scale #	
w	w	w	w	w		w	No.	w	w	Mesh	
			900							900	
			850								20
710	800	850	850			850	20		800		
	710	710	800			710	25				24
			630							630	
			600								28
500	560	600	600			600	30		560		
	500	500	500	500		500	35		500	500	32
			450	450					450		
			425	425					425	425	35
355	400	425	400	400		425	40		400	425	
	355	355	355	355		355	45		355	355	42
			315	315					315		
			300	300					300	300	48
250	280	300	280	300		300	50		280	300	
	250	250	250	250		250	60		250	250	60
			224	224					224		
			212	212					212	212	65
180	200	212	200	200		212	70		200	212	
	180	180	180	180		180	80		180	180	80
			160	160					160		
			150	150					150	150	100
125	140	150	140	140		150	100		140	140	
	125	125	125	125		125	120		125	125	115
			112	112					112		
			106	106					106	106	150
90	100	106	100	100		106	140		100	106	
	90	90	90	90		90	170		90	90	170
			80	80					80		
			75	75					75	200	200
63	71	75	71	71		75	200		71	75	
	63	63	63	63		63	230		63	63	250
			56	56					56		
			53	53					53	270	270
45	50	53	50	50		53	270		50	53	
	45	45	45	45		45	325		45	45	325
			40	40					40		
			38	38					38	400	400
R10	36	38	36	36		38	400		36	38	
32			32	32		32	450		32	32	450
25			25	25		25	500		25	25	500
20			20	20		20	635		20	20	635
				16						15	
				10						10	
				5						5	

# Woven wire cloth    ⊞ Electroformed sheet

© Copyright 2025 by NEXOPART  
\*National edition of ISO 3310. National edition of ISO 3310.

Our sieve bottoms for test sieves comply with the standards according to the current revision level. Our wire cloth for test sieves comply with the standards acc. to the valid revision level.

# Test sieve machines. Precision in an entirely new dimension

Our goal is to make your work easier and more efficient. That's why we have developed machines that are simple and easy to operate. No complicated instructions, no confusing interfaces - just simplicity at its finest. NEXOPART test sieve machines are ready to use in no time and ensure a trouble-free sieving process every time. But do not let the simplicity fool you. Our machines are equipped with state-of-the-art technology that guarantees accurate and reliable results.

Whether you are analyzing samples or performing quality control testing, with their innovative features and rugged designs, our test sieve machines are perfectly made to meet the demands of both a busy lab and a production environment.



# NEXOPART EML 200. Raises proven methods to the next level

With state-of-the-art features and customizable options, our test sieve shakers of the EML-series can be perfectly tailored to satisfy your particular requirements enabling seamless analysis of your materials, regardless of their shape, size, or composition.

The **EML 200 Pure** is the basic model and is very easy to operate and control. You can choose between two fixed amplitudes for coarse or fine materials. A defined interval also occurs every 10 seconds. Perfect for those who are looking for simple and straightforward results.



Sample weights of up to 3 kg



Measuring range from 20 µm up to 125 mm



One predefined interval

The **EML 200 Premium** is equipped with a user-friendly data interface that allows an easy selection of amplitudes. It is perfect for those users who have special requirements for accurate and repeatable sieve analysis.



Sample weights of up to 3 kg



Measuring range from 20 µm up to 125 mm





Variable interval





EML 200 Premium Remote for wet sieving

The **EML 200 Premium Remote** is exceptionally suitable for wet sieve analyses. It not only offers all the features of the EML 200 Premium but is additionally equipped with a separate control unit and a cover with an integrated full cone nozzle.

-  **Sample weights of up to 3 kg**
-  **Measuring range from 20 µm up to 125 mm**
-  **Wet and dry sieving**

# NEXOPART UWL 400.



## The greatest dimension in precision

Sieving material weighing up to 20 kg? Wet or dry sieving? No problem for our NEXOPART UWL 400. It is NEXOPART's largest and most powerful 3D test sieve shaker to date and equipped with two three-phase unbalance motors, it is able to easily analyze large and heavy bulk materials.



EML 315 dry sieving



The **EML 315** is available for wet or dry sieve analysis. You can use this machine for various sieves with diameters of up to 315 mm. The EML 315 for wet sieving differs from the dry sieving version in that it is equipped with a cover with an integrated wide spreading spray diffuser as well as further accessories for wet sieving. Both machine models feature a separate control unit.

-  **Sample weights of up to 6 kg**
-  **Measuring range from 20 µm up to 125 mm**
-  **Wet and dry sieving**



EML 450 for wet sieving

The **EML 450** is the heavyweight of our EML series and offers options for wet or dry sieve analysis. With sample weights of up to 15 kg, it offers the largest analysis surface area and is ideal for test sieves with diameters of up to 450 mm. The EML 450 for wet sieving differs from the dry sieving version in that it is equipped with a cover with an integrated wide spreading spray diffuser as well as further accessories for wet sieving. Both machine models feature a separate control unit.



-  **Sample weights of up to 15 kg**
-  **Measuring range from 20 µm up to 125 mm**
-  **Wet and dry sieving**





NEXOPART TwinNut®

The TwinNut® quick-release clamping system is ideal particularly when sieving with frequently varying sieve tower heights. Simply open the TwinNut®, slide it to the desired position on the guide bars, and adapt the height without time-consuming screwing and unscrewing.

The TwinNut® is available for the EML 200 Premium - UWL 400 models.

-  **Sample weights of up to 20 kg**
-  **Wet and dry sieving**



-  **Measuring range from 20 µm up to 125 mm**
-  **Two three-phase unbalance motors**

# NEXOPART e200 LS air jet sieve machine. Our solution for very fine powders

The NEXOPART e200 LS unfolds its full effectiveness exactly where fine powders often clog the test sieve, as they have an increased tendency to agglomerate and make sieve analysis more difficult. The e200 LS, in contrast, is perfectly suited for separating, fractioning and analyzing grain sizes of fine to very fine powders in various branches of industry such as mineral, chemical, pharmaceutical (by complying with 21 CFR Part 11), toner production, food and beverage, cement and construction materials sectors. Quiet, fast and efficient, it delivers accurate measurement results and a high level of reproducibility.

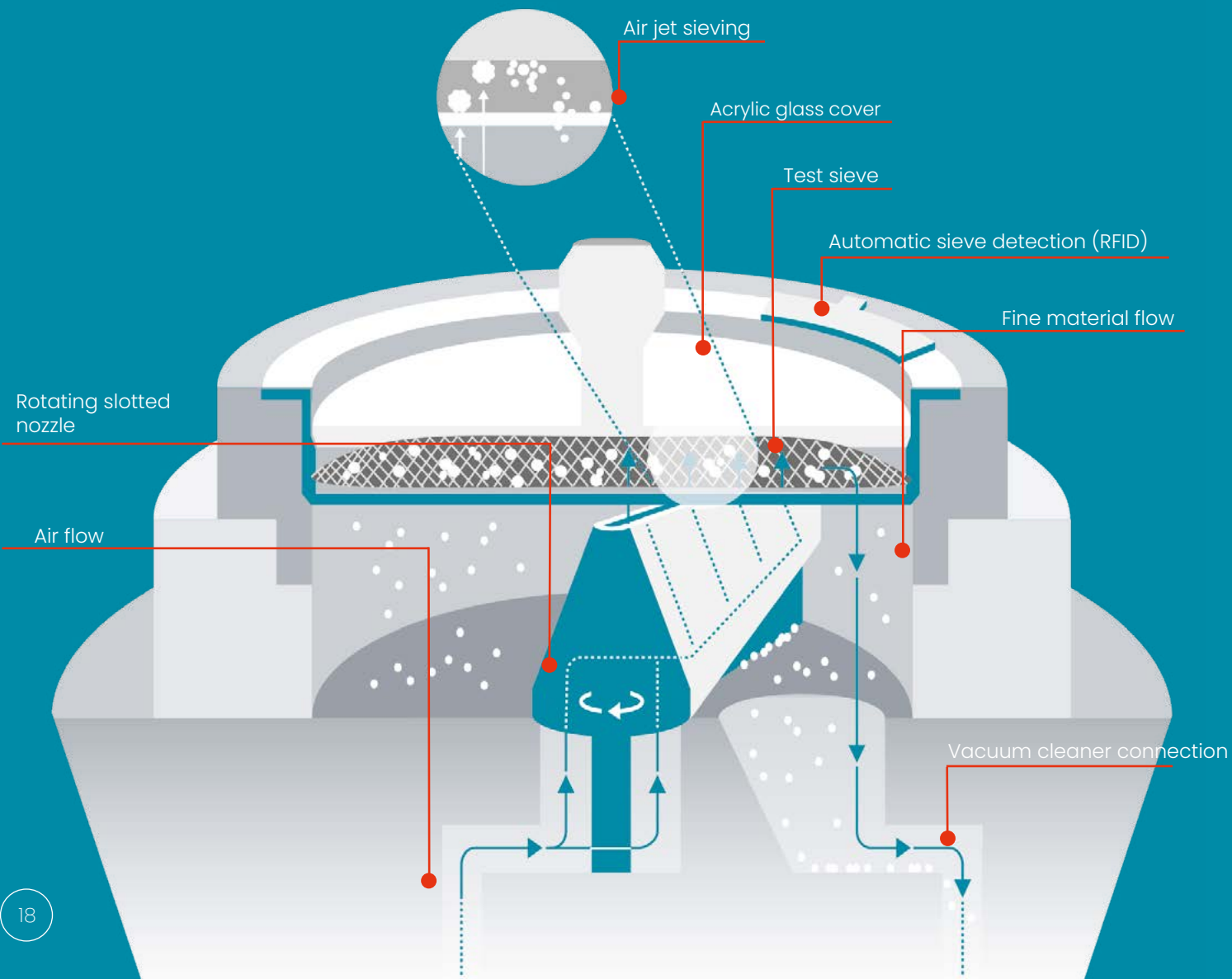

## Two-components. Perfect results

A rotating slot nozzle inside the screen chamber of the e200 LS and an external industrial vacuum cleaner work together to produce perfect results: While the vacuum cleaner creates a vacuum inside the sieving chamber, the extremely narrow slot of the slotted nozzle accelerates the air mass entering from below through the sieve wire cloth. The result: Fine particles are separated quickly and efficiently.

Also impressive are the integrated software (eControl) and user-friendly and simple operation via touch display of the e200 LS. You can find the right package for you and your daily laboratory routine from our selection of four software packages: **LITE**, **BASIC**, **ULTIMATE**, and **SECURITY**. And the best part is: You remain flexible and can expand each package at any time with the next higher upgrade.



 Sample weights of up to 30 g

 Measuring range from 10 µm up to 4 mm

 Simple and fast to operate

 Upgradeable at any time





# W.S. TYLER® RO-TAP®.

## Unique shapes require one-of-a-kind processes

For those who face a challenge with their bulk materials, the RO-TAP® from W.S. TYLER® is a good solution. It imitates the classic hand sieving by a horizontal rotary motion with simultaneous tapping motion. The test sieve shaker from our American affiliate W.S. TYLER® in Mentor, Ohio works three-dimensionally and with its unique process provides you with the perfect solution for cubic particles such as chili powder, abrasives and tobacco. With the RO-TAP®, the challenges you have been faced with in your daily laboratory routine are now a thing of the past.



Ro-Tap® RX-29

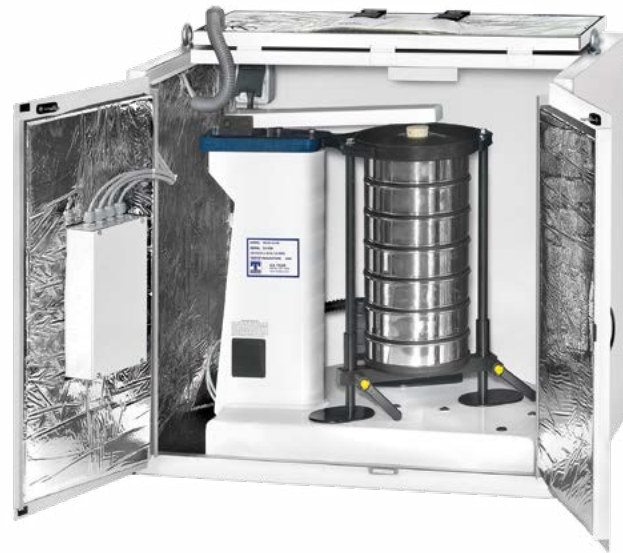

CE-compliant Ro-Tap® RX-29 with soundproof cabinet and external control system



Sample weights of up to 3 kg



Measuring range from 20 µm up to 125 mm



Recommended by the FEPA standard



Rotation + tapping motion

# NEXOPART UFA.

## Ultrasonic frequency variation

Ultrasonic frequency variation for test sieves becomes an important tool for you when it comes to more efficient sieving of powders at critical size cuts of  $\leq 300 \mu\text{m}$ . This process involves moving the screen wire cloth by uniformly distributed ultrasonic waves at continuously varying frequencies. These high-frequency vibrations reduce the frictional resistance between particles and the sieve wire cloth. The result is minimized clogging tendency, destruction of agglomerates, increased sieving performance and shorter sieving. This makes sieving with test sieve shakers possible for some bulk materials in the first place.



AGS ultrasonic frequency variation with a clamping ring and converter on the EML 200 Premium test sieve shaker

# CPA 2-1. LABORATORY and ONLINE

Are you looking for a reliable analyzer for dry and free-flowing particles? Then simply use the **Dynamic Image Analysis (DIA)** technology for bulk materials such as fertilizers, blasting abrasives, sand, coal, food products, pharmaceuticals, plastics, seeds, ceramics and glass. How you benefit: You are provided with extensive and detailed information about the shape and size of your product, precise evaluation with the help of the NEXOPART CpaServ software and a plethora of parameters immediately and digitally.

The **CPA 2-1** dynamic image analyzer provides you quickly, reliably and automatically complete measurement results on the size distribution and shape of your materials for your everyday laboratory work.





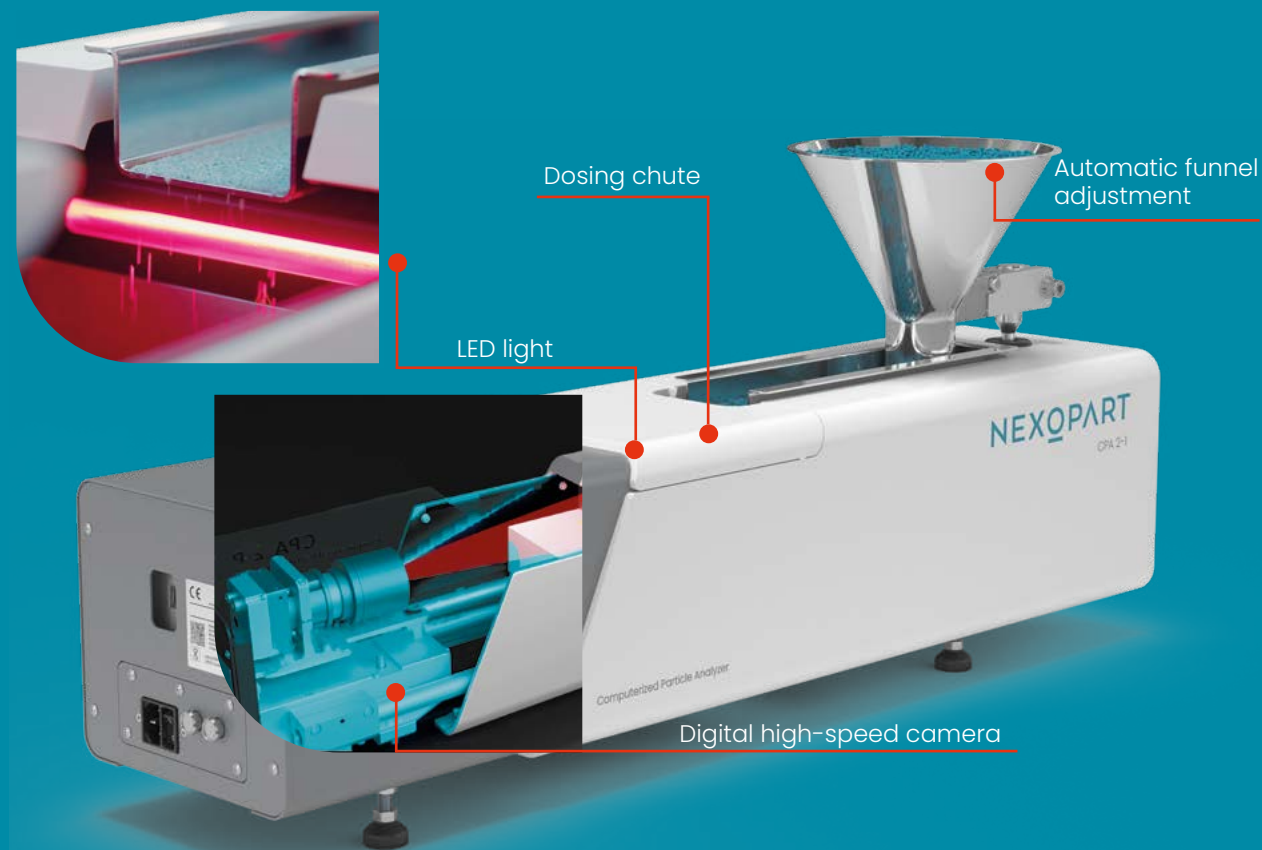









**CPA 2-1 ONLINE** can be used in a variety of ways such as incoming goods inspection, production control and process monitoring. Also combined with an automatic sampling system, it can be easily connected via MODBUS TCP to a customer process control system (PCS). This is not mandatory, however; even in stand-alone automatic mode, the system can be installed flexibly and is able to deliver the results centrally.

 **Measuring range from 20 µm up to 30 mm**



# Dynamic image analysis

Our NEXOPART CPA devices are based on the dynamic image analysis (DIA) method in accordance with ISO 13322-2. You can rely on reliable and computer-aided digital-optical image processing. Your material samples are automatically dosed via a feed chute. After arriving in the measurement channel, an LED lighting array and a digital line scan camera operate using the backlight method. The built-in line scan camera scans the free-flowing bulk materials individually. Nothing can falsify your measurement results as the particles are neither cropped nor lost during the "scan" principle of operation. Instead, high-resolution measurement values are calculated for all particles and an ID is assigned and stored for each individual particle in our CpaServ software. NEXOPART CPS devices thus achieve 100% measurement accuracy.

Chart	Minimum Fer...	Equivalent ...	Aspect ratio	Circularity
	0.8996	1.1418	1.9265	0.78088
	0.36203	0.38618	1.2166	0.91714
	0.36846	0.43854	1.6147	0.85206
	0.6006	0.63104	1.2439	0.91061
	0.38483	0.4225	1.5154	0.81918
	0.97142	1.0788	1.3396	0.87992
	0.62359	0.62868	1.1252	0.85278
	0.56056	0.7063	1.6236	0.89842
	0.69487	0.84427	1.6112	0.85435
	0.75293	0.89626	1.4801	0.85534
	0.55244	0.58253	1.2375	0.89785
	0.63082	0.66703	1.2936	0.82945
	0.5005	0.64174	1.7777	0.85398
	0.68068	0.71413	1.1873	0.85871
	0.40242	0.42052	1.393	0.80702

Up to 10,000 particles can be detected, analyzed and counted per second. Our CpaServ software groups the scanned particles to form an endless data record and evaluates the data in real time parallel to the measuring process.



AS6 Autosampler

Would you like to utilize the potential of your NEXOPART CPA 2-1 better? With the **AS 6, AS 12, or AS 24** Autosampler, you can automate loading of a large number of samples. Increase your productivity by extending operating hours beyond normal laboratory hours (overnight operation, for example).

**CPA 2-1 ONLINE** is ideally suited for analyzing fertilizers, coal and food products such as salt and sugar, as well as sand and abrasives. An online solution during the ongoing production process gives you two decisive advantages at once:

- Sample analysis at regular intervals without interrupting production
- Resistance to harsh environmental conditions such as heat, cold, dust and humidity

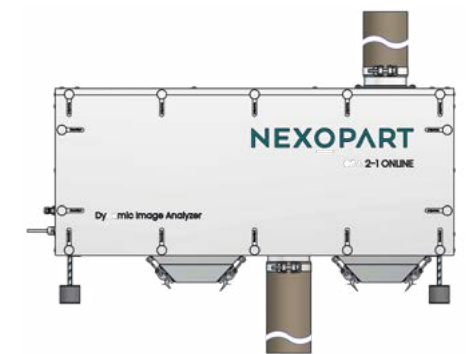

CPA 2-1 ONLINE



# NEXOPART

## Evaluation software

### eControl. CpaServ.

Is evaluating your analysis results equally as important to you as the analysis itself? NEXOPART has the matching software of your test sieve machine. All of the data is documented and saved for quality assurance of your measurement results. The result: Graphic charts and extensive documentation of your statistics and evaluations.

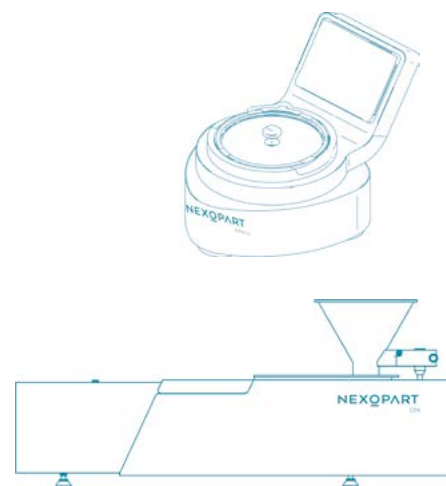

The **NEXOPART eControl** software was developed for the e200 LS air jet sieve machine. From our selection of four software packages **LITE**, **BASIC**, **ULTIMATE** and **SECURITY**, you can choose the right package for you and upgrade your current software package at any time.

The CPA 2-1 analyzer is backed by the intelligence of the **NEXOPART CpaServ** software. Simplest operability, a modern user interface and automated measuring processes define your daily work routine. Once the SOPs have been defined, you can carry out and complete other analyses entirely digitally with just one click. The analyses are evaluated and processed in real time so that all data are immediately available to you when the measurement is completed.

## Revolution in your lab routine

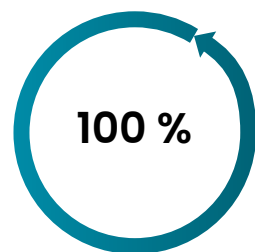

With NEXOPART software systems, your measurement results are 100% reliable and reproducible.



Customized special solutions for your working environment mean cost and space savings for you of up to + 42%.

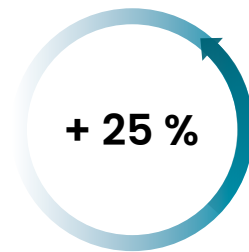

The easy operability of the NEXOPART devices results in time savings of approx. + 25%.

# NEXOPART USC.

## Clean test sieves for perfect results

If you attach great importance to perfect analysis results, then clean test sieves are an important part of your daily work. NEXOPART provides a solution to this problem as well: The various versions available of our ultrasonic cleaning devices guarantee a proper, gentle as well as energy-saving sieve cleaning. Particularly when combined with our USC cleaning concentrate, cleaning with these devices is more thorough and take less time than manual cleaning.

In order to thoroughly and gently remove the finest of particles from test sieves, NEXOPART offers the **NEXOPART USC 200 S** for test sieves with diameters up to 203 mm. You can use the **NEXOPART USC 500 S** for sieve diameters of up to 500 mm.



Using the **NEXOPART USC 200 Multi**, you can clean up to five test sieves at once with diameters up to 203 mm.



# NEXOPART Service. Personally and near you

You will receive comprehensive test certificates and services for all products from our company. In addition to sustainable and compliant quality inspections, maintenance and repairs, you can also rent and test our test sieve machines. You will get the complete package from us.

# A central contact person

Do you have any questions about our products and services?  
Our competent team of consultants and your personal contacts are always at your service – by phone, email, or on site. Internationally, our worldwide NEXOPART sales and service network is at your disposal. You would like to be maximally flexible?  
No matter where or when – you can order your laboratory supplies conveniently 24/7 online through our webshop.

- Factory certificate 2.1 according to DIN EN 10204 free of charge with the purchase of our test sieves. Test sieve mesh and test sieves are manufactured in accordance with all the applicable standards (quality management system certified in accordance with ISO 9001:2015).
- On request: an additional acceptance test certificate 3.1 in accordance with DIN EN 10204. The tests can be carried out at two confidence levels as a certifying or calibrating measurement.
- Certification of new and recertification of used test sieves using a calibrated video analysis system at your site or in our factory laboratory. The BSA measuring system meets the current version of the ISO 3310-1 and ASTM E11 requirements for test sieves.
- Testing of the functionality, safety, and condition of our EML-series and RO-TAP® test sieve shakers and CPA devices on site or in our factory in Oelde. After successful testing, we will attach a test seal to the test sieve shaker and issue an acceptance test certificate 3.1 in accordance with DIN EN 10204.
- On request: Extension of the warranty of NEXOPART EML-series and RO-TAP® test sieve shakers and CPA units from two to four years. Annual inspections will then be carried out on your or our premises.
- Test of the functionality, safety, and condition of the NEXOPART e200 LS air jet sieving machine. Directly on site at your premises or in our plant in Gersthofen. After testing, you will receive a system log.
- Commissioning and training: To ensure optimal performance of the sieve analyses, we will be glad to provide your employees face-to-face or online training.
- IQ/OQ in accordance with GMP: Installation Qualification (IQ) is the documented proof, prior to putting the equipment into service, that the equipment meets the requirements you are required to fulfill with regard to identity, installation, compliance with directives, and documentation. Operational Quality (OQ) ensures that the machines operate as designed and that they operate properly over the entire scope of the process-critical parameters.

NEXOPART's E-Shop is accessible  
everywhere at all times



“Our goal at NEXOPART is  
clearly defined: We want to  
inspire our customers with  
precision, simplicity and  
quality.”

Markus Schönwetter, Technical Director at NEXOPART



**NEXOPART GmbH & Co. KG**

A Haver & Boecker and Hosokawa Alpine Company  
Ennigerloher Str. 64  
59302 Oelde  
Germany

**NEXOPART GmbH & Co. KG**

A Haver & Boecker and Hosokawa Alpine Company  
Augsburger Str. 164  
86368 Gersthofen  
Germany

[sales@nexopart.com](mailto:sales@nexopart.com)  
[www.nexopart.com](http://www.nexopart.com)



**NEXOPART**

simplicity for your lab